

sch-remote.com

EVOR01xx

Data Sheet

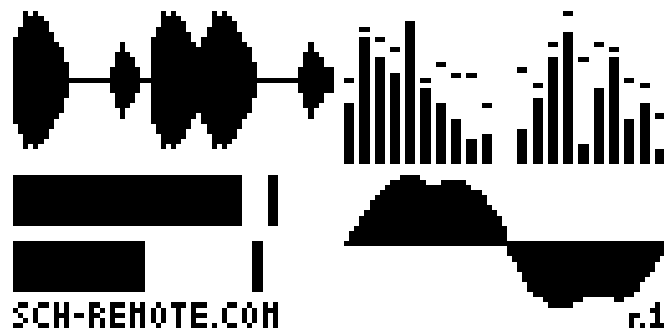

LCD display based VU meter / Oscilloscope /
RTA / Envelope / X-Y plot

Features

- 2.7" FSTN LCD Display
- Single 5V power supply
- 5 viewing modes: VU meter, 10 band real time spectrum, Oscilloscope, Envelope, X-Y plot
- Top/bottom or left/right view of each mode
- 4 references for 0dB: -10 dBv, 0 dBv, 0dBu, 4dBu
- Custom 0dB reference setup by an external resistor
- Wide bandwidth input signal 10 Hz - 20 kHz

Table of contents

Wiring diagram.....	3
Jumper configurations and contrast adjustment.....	4
Mode VU meter.....	6
Mode RTA (10 band spectrum).....	6
Mode Oscilloscope.....	7
Mode Envelope.....	7
Mode X-Y plot.....	8
Custom 0 dB reference setup.....	8
Electrical characteristics.....	9
Mechanical characteristics.....	10

Wiring diagram

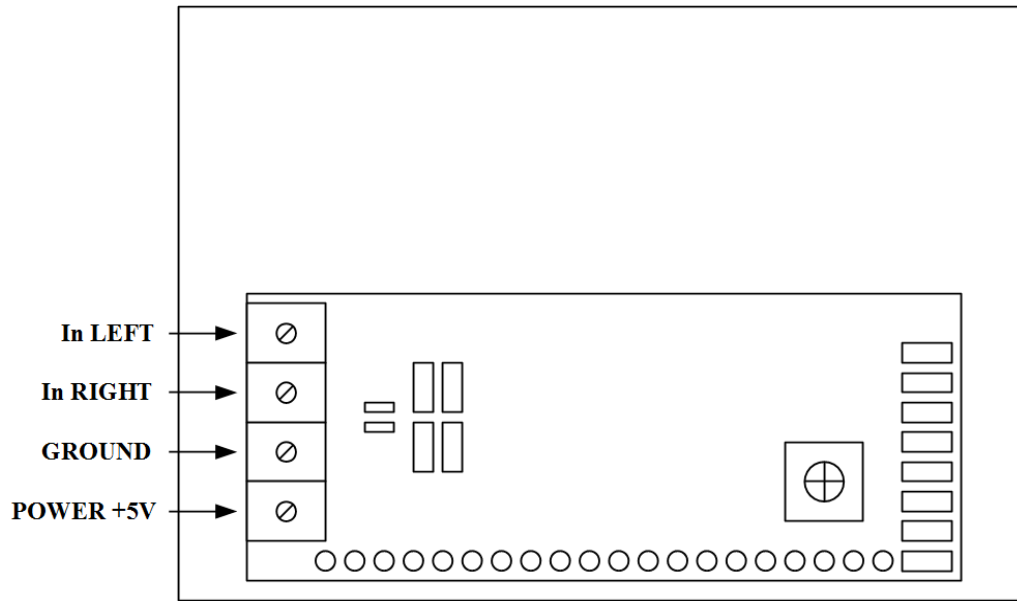

Figure 1: Wiring diagram (bottom view)

Table 1: Wiring

Pin	Description
In LEFT	Audio signal for left channel.
In RIGHT	Audio signal for right channel.
GROUND	Audio and power ground.
POWER +5V	Power supply.

Jumper configurations and contrast adjustment

Contrast adjustment

Contrast of LCD displays is highly dependent from supply voltage and preferred viewing angle. To obtain best results, it is adjustable from the pot mounted on back side of the board.

0dB reference

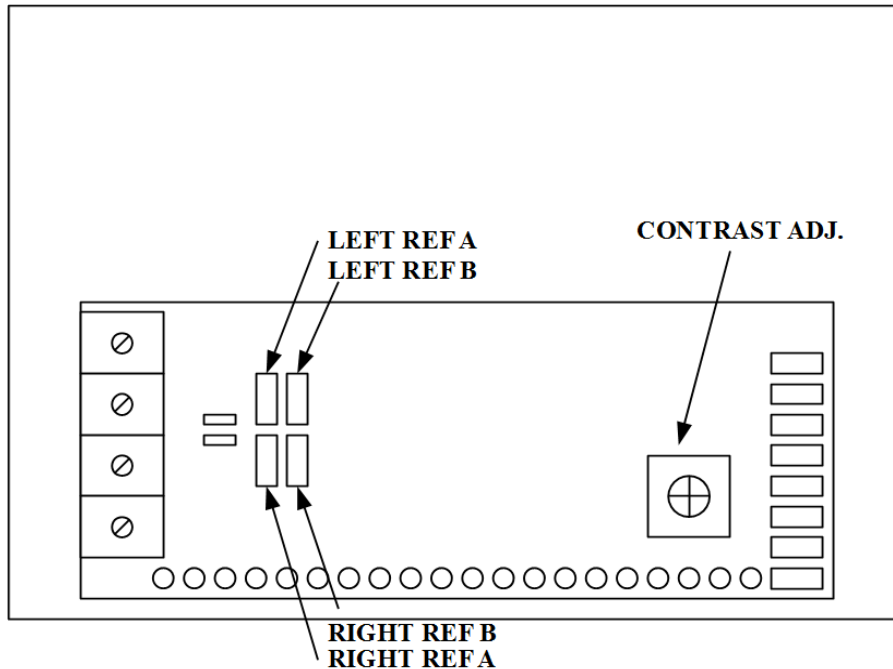

Figure 2: 0dB reference jumpers

Each channel has 2 jumpers allowing 4 different configurations of 0dB reference point. That configuration all input signals with different levels to be matched correctly to display scale. If the input signal is out of the preset levels, a custom reference can be obtained. Custom setup id described in Custom 0 dB reference setup section.

Table 2: 0dB reference jumpers

A B	0 mark in dBv	0 mark in dBu	0 mark in Vrms
□ □	-10 dBv	-7.78 dBu	0.32 Vrms
■ □	-2.2 dBv	0 dBu	0.77 Vrms
□ ■	0 dBv	2.2 dBu	1 Vrms
■ ■	1.78 dBv	4 dBu	1.23 Vrms

□ - jumper removed ■ - jumper installed

Display mode

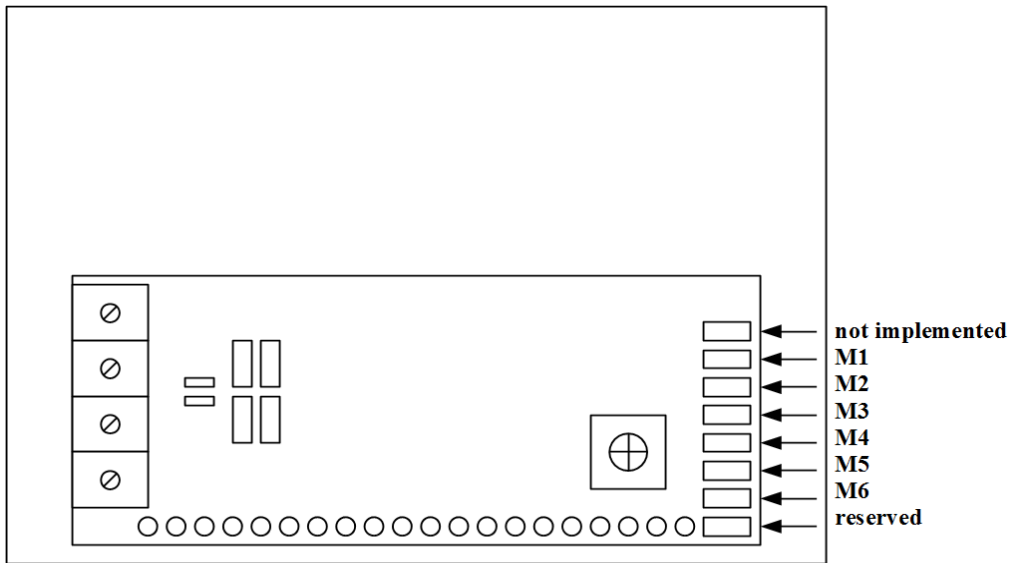

Figure 3: Mode jumpers

There are 6 mode selecting jumpers. They can be split into 3 primary groups:

- M1, M2 Global appearance. M1 toggle display inversion, M2 toggle horizontal and vertical view
- M3, M4 These jumpers toggle various features, depending on selected view mode
- M5, M6 View mode selection. Used to select one of the 5 possible view modes

Table 3: Jumper M1 Display inversion

<input type="checkbox"/> M1 jumper removed	<input checked="" type="checkbox"/> M1 jumper installed

Jumpers M2, M3 and M4 are described in details in related views

M5 M6	View
<input type="checkbox"/> <input type="checkbox"/>	VU meter
<input type="checkbox"/> <input checked="" type="checkbox"/>	Oscilloscope
<input checked="" type="checkbox"/> <input type="checkbox"/>	Envelope
<input checked="" type="checkbox"/> <input checked="" type="checkbox"/>	10 band real time spectrum
<input checked="" type="checkbox"/> <input type="checkbox"/> *	X-Y plot

*jumper is placed across M5 and M6, at left side of pins array

- jumper removed - jumper installed



Mode VU meter

M5 M6

M2 horizontal/vertical view

M3 show/hide peaks

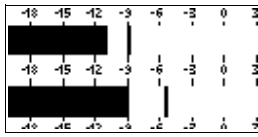
M4 log/linear scale

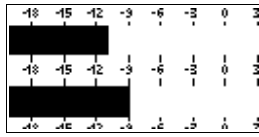
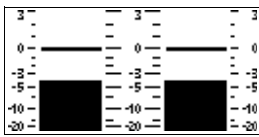
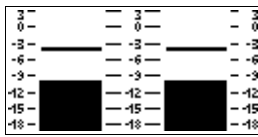
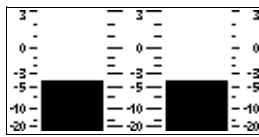
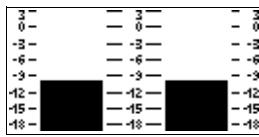
<p>M2 <input type="checkbox"/> M3 <input type="checkbox"/> M4 <input type="checkbox"/> hor., peaks, log</p> 	<p>M2 <input type="checkbox"/> M3 <input type="checkbox"/> M4 <input checked="" type="checkbox"/> hor., peaks, linear</p> 	<p>M2 <input type="checkbox"/> M3 <input checked="" type="checkbox"/> M4 <input type="checkbox"/> hor., no peaks, log</p> 	<p>M2 <input type="checkbox"/> M3 <input checked="" type="checkbox"/> M4 <input checked="" type="checkbox"/> hor., no peaks, linear</p> 
<p>M2 <input checked="" type="checkbox"/> M3 <input type="checkbox"/> M4 <input type="checkbox"/> vert., peaks, log</p> 	<p>M2 <input checked="" type="checkbox"/> M3 <input type="checkbox"/> M4 <input checked="" type="checkbox"/> vert., peaks, linear</p> 	<p>M2 <input checked="" type="checkbox"/> M3 <input checked="" type="checkbox"/> M4 <input type="checkbox"/> vert., no peaks, log</p> 	<p>M2 <input checked="" type="checkbox"/> M3 <input checked="" type="checkbox"/> M4 <input checked="" type="checkbox"/> vert., no peaks, linear</p> 

Mode RTA (10 band spectrum)

M5 M6

M2 horizontal/vertical view

M3 show/hide peaks

M4 solid/separated bars

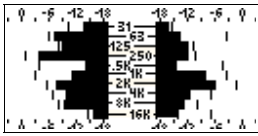
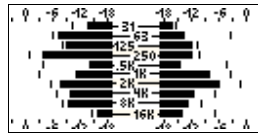
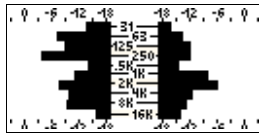
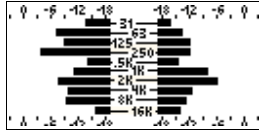
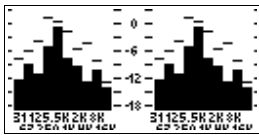
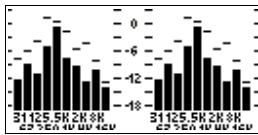
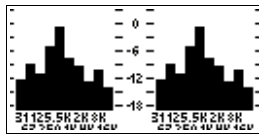
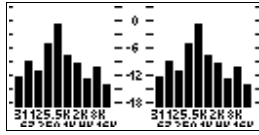
<p>M2 <input type="checkbox"/> M3 <input type="checkbox"/> M4 <input type="checkbox"/> hor., peaks, solid</p> 	<p>M2 <input type="checkbox"/> M3 <input type="checkbox"/> M4 <input checked="" type="checkbox"/> hor., peaks, separated</p> 	<p>M2 <input type="checkbox"/> M3 <input checked="" type="checkbox"/> M4 <input type="checkbox"/> hor., no peaks, solid</p> 	<p>M2 <input type="checkbox"/> M3 <input checked="" type="checkbox"/> M4 <input checked="" type="checkbox"/> hor., no peaks, separated</p> 
<p>M2 <input checked="" type="checkbox"/> M3 <input type="checkbox"/> M4 <input type="checkbox"/> vert., peaks, solid</p> 	<p>M2 <input checked="" type="checkbox"/> M3 <input type="checkbox"/> M4 <input checked="" type="checkbox"/> vert., peaks, separated</p> 	<p>M2 <input checked="" type="checkbox"/> M3 <input checked="" type="checkbox"/> M4 <input type="checkbox"/> vert., no peaks, solid</p> 	<p>M2 <input checked="" type="checkbox"/> M3 <input checked="" type="checkbox"/> M4 <input checked="" type="checkbox"/> vert., no peaks, separated</p> 

Mode Oscilloscope

M5 M6

M2 horizontal/vertical view

M3 fill/line draw

M4 1x/2x scale

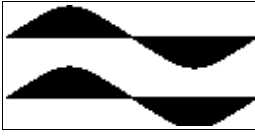
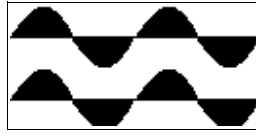
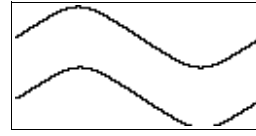
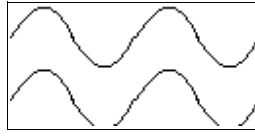
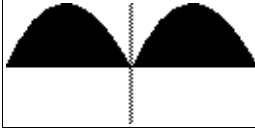
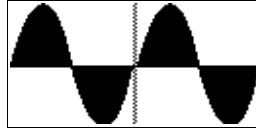
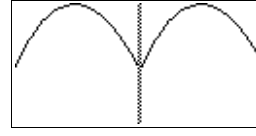
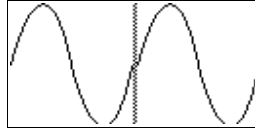
<p>M2 <input type="checkbox"/> M3 <input type="checkbox"/> M4 <input type="checkbox"/> hor., fill, 1x</p> 	<p>M2 <input type="checkbox"/> M3 <input type="checkbox"/> M4 <input checked="" type="checkbox"/> hor., fill, 2x</p> 	<p>M2 <input type="checkbox"/> M3 <input checked="" type="checkbox"/> M4 <input type="checkbox"/> hor., line, 1x</p> 	<p>M2 <input type="checkbox"/> M3 <input checked="" type="checkbox"/> M4 <input checked="" type="checkbox"/> hor., line, 2x</p> 
<p>M2 <input checked="" type="checkbox"/> M3 <input type="checkbox"/> M4 <input type="checkbox"/> vert., fill, 1x</p> 	<p>M2 <input checked="" type="checkbox"/> M3 <input type="checkbox"/> M4 <input checked="" type="checkbox"/> vert., fill, 2x</p> 	<p>M2 <input checked="" type="checkbox"/> M3 <input checked="" type="checkbox"/> M4 <input type="checkbox"/> vert., line, 1x</p> 	<p>M2 <input checked="" type="checkbox"/> M3 <input checked="" type="checkbox"/> M4 <input checked="" type="checkbox"/> vert., line, 2x</p> 







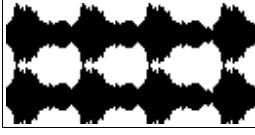

Mode Envelope

M5 M6

M2 horizontal/vertical view

M3 log/linear scale

M4 1x/2x scale

<p>M2 <input type="checkbox"/> M3 <input type="checkbox"/> M4 <input type="checkbox"/> hor., linear, 1x</p> 	<p>M2 <input type="checkbox"/> M3 <input type="checkbox"/> M4 <input checked="" type="checkbox"/> hor., linear, 2x</p> 	<p>M2 <input type="checkbox"/> M3 <input checked="" type="checkbox"/> M4 <input type="checkbox"/> hor., log, 1x</p> 	<p>M2 <input type="checkbox"/> M3 <input checked="" type="checkbox"/> M4 <input checked="" type="checkbox"/> hor., log, 2x</p> 
<p>M2 <input checked="" type="checkbox"/> M3 <input type="checkbox"/> M4 <input type="checkbox"/> vert., linear, 1x</p> 	<p>M2 <input checked="" type="checkbox"/> M3 <input type="checkbox"/> M4 <input checked="" type="checkbox"/> vert., linear, 2x</p> 	<p>M2 <input checked="" type="checkbox"/> M3 <input checked="" type="checkbox"/> M4 <input type="checkbox"/> vert., log, 1x</p> 	<p>M2 <input checked="" type="checkbox"/> M3 <input checked="" type="checkbox"/> M4 <input checked="" type="checkbox"/> vert., log, 2x</p> 

Mode X-Y plot

M5 M6

jumper is placed across M5 and M6, at left side of pins array

M2 diagonal/view

M3 256/128 displayed samples

M4 fast/slow refresh

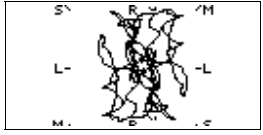
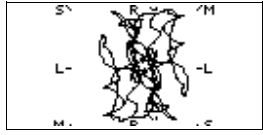
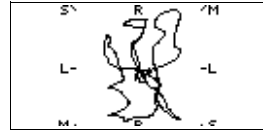
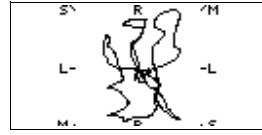
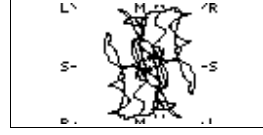
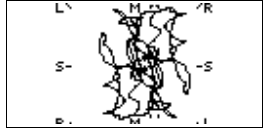
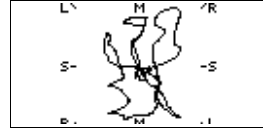
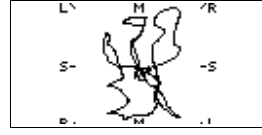
<p>M2 <input type="checkbox"/> M3 <input type="checkbox"/> M4 <input type="checkbox"/> diag., 256 smp., fast</p> 	<p>M2 <input type="checkbox"/> M3 <input type="checkbox"/> M4 <input checked="" type="checkbox"/> diag., 256 smp., slow</p> 	<p>M2 <input type="checkbox"/> M3 <input checked="" type="checkbox"/> M4 <input type="checkbox"/> diag., 128 smp., fast</p> 	<p>M2 <input type="checkbox"/> M3 <input checked="" type="checkbox"/> M4 <input checked="" type="checkbox"/> diag., 128 smp., slow</p> 
<p>M2 <input checked="" type="checkbox"/> M3 <input type="checkbox"/> M4 <input type="checkbox"/> vert., 256 smp., fast</p> 	<p>M2 <input checked="" type="checkbox"/> M3 <input type="checkbox"/> M4 <input checked="" type="checkbox"/> vert., 256 smp., slow</p> 	<p>M2 <input checked="" type="checkbox"/> M3 <input checked="" type="checkbox"/> M4 <input type="checkbox"/> vert., 128 smp., fast</p> 	<p>M2 <input checked="" type="checkbox"/> M3 <input checked="" type="checkbox"/> M4 <input checked="" type="checkbox"/> vert., 128 smp., slow</p> 

Custom 0 dB reference setup

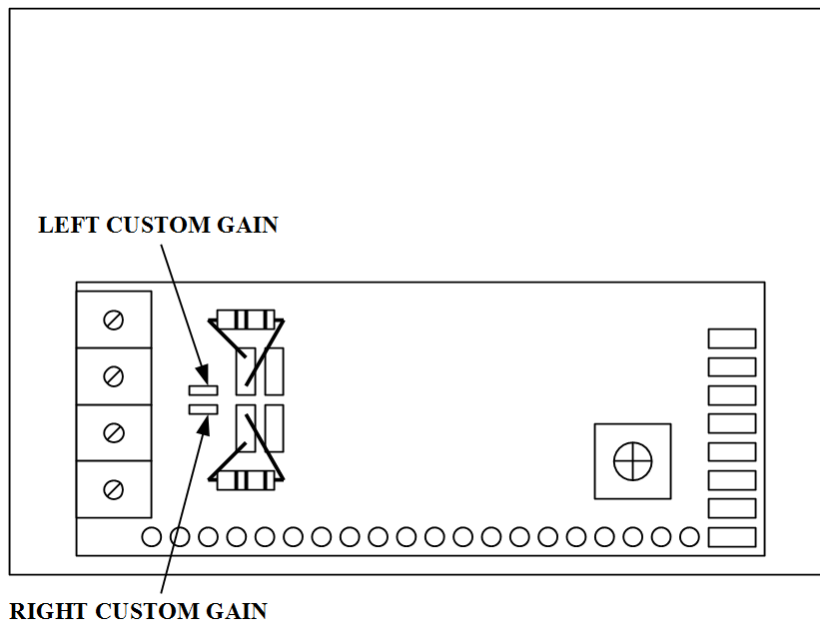

Figure 4: Custom 0dB reference

To obtain a custom 0dB reference level is required to de-solder the left and right gain bridges. In place of A jumpers should be connected resistors with values calculated by following formula: $R[K\Omega] = (30/V_{ref}) - 39$, where V_{ref} is the RMS level in volts for 0dB. The B jumpers must be open.

Electrical characteristics

DC characteristics

 $0^{\circ}\text{C} < T_a < 70^{\circ}\text{C}$

Symbol	Characteristic	Min	Typ	Max	Units
V _{DD}	Supply Voltage	4.5	5	5.5	V
I _{DD}	Operating Current		62	80	mA
V _{IN}	Input level DC offset	-5	0	5	V
	Input level AC peak-peak			5	V
R _{IN}	Input impedance	46	51	56	kΩ

AC characteristics

Symbol	Characteristic	Min	Typ	Max	Units
F _{MIN}	Minimum input frequency		10		Hz
F _{MAX}	Maximum input frequency		20		kHz
	Maximum input frequency X-Y plot		16		kHz

Mechanical characteristics

